



BOC Group – Enabling Transformation of Business and IT

ADONIS Interfaces and Collaboration Capabilities



- I. **Communication, Collaboration and Integration**
- II. Summary

Overview of BOC Management Office Interfaces

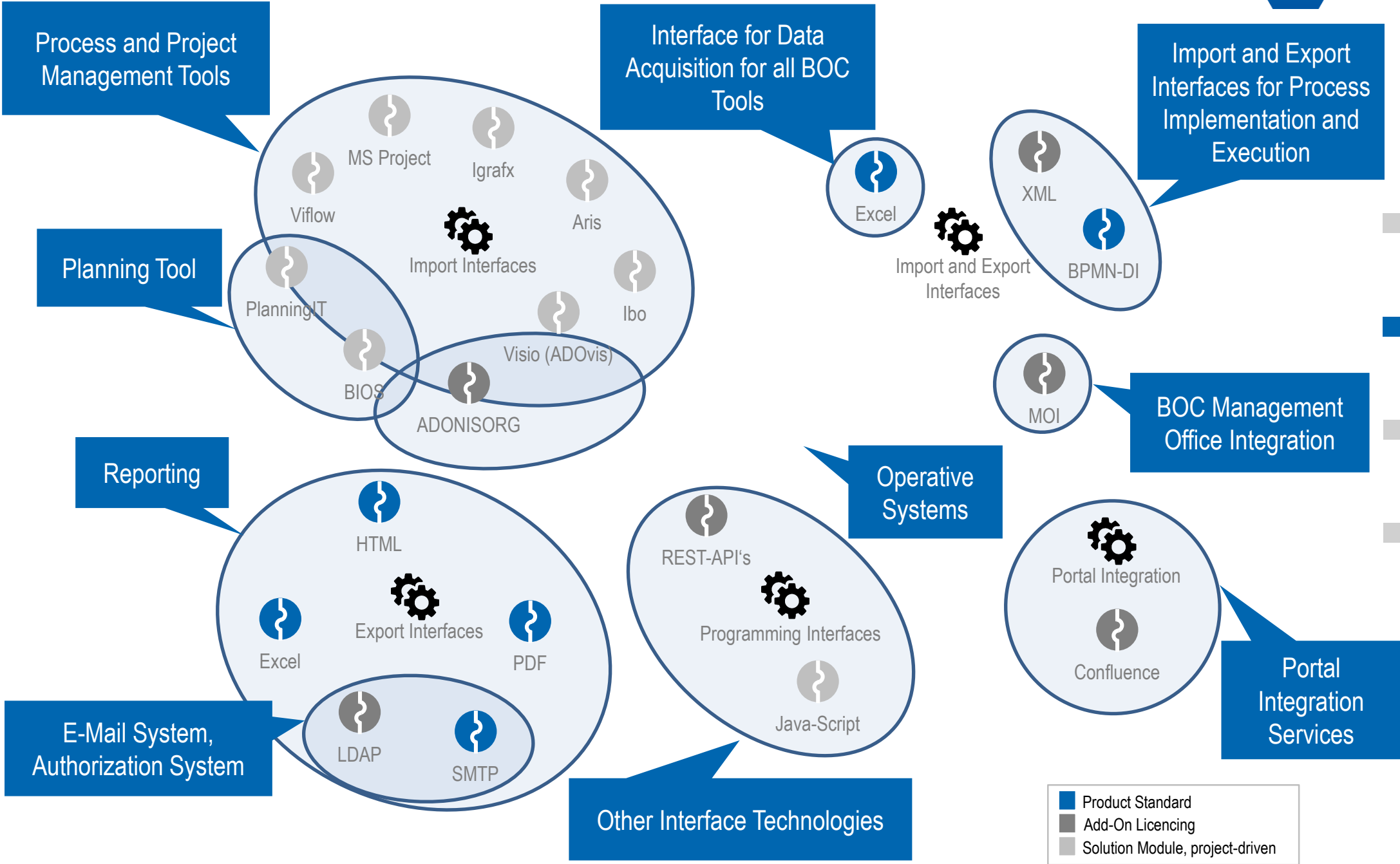

Flexibility and independence

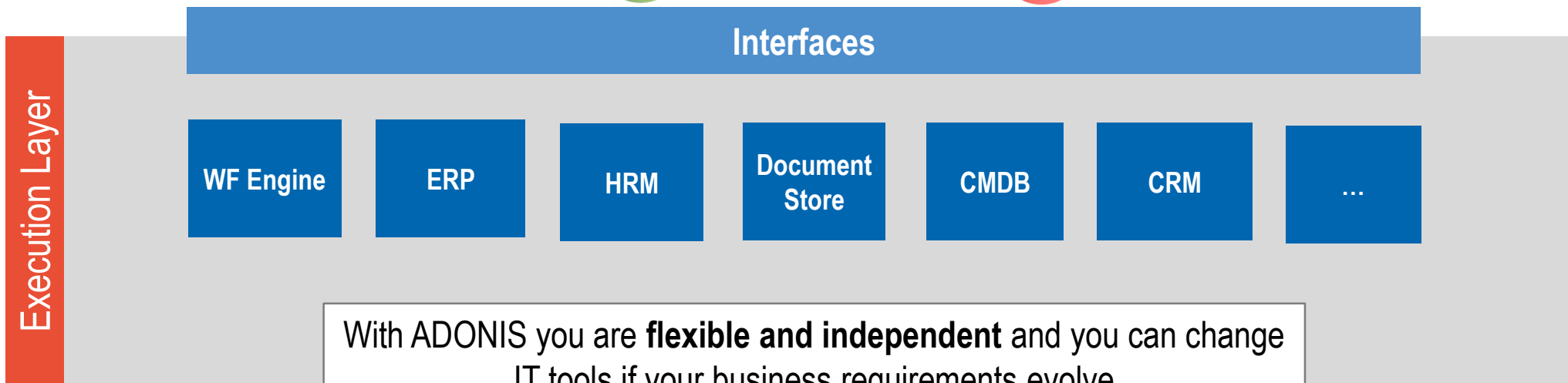
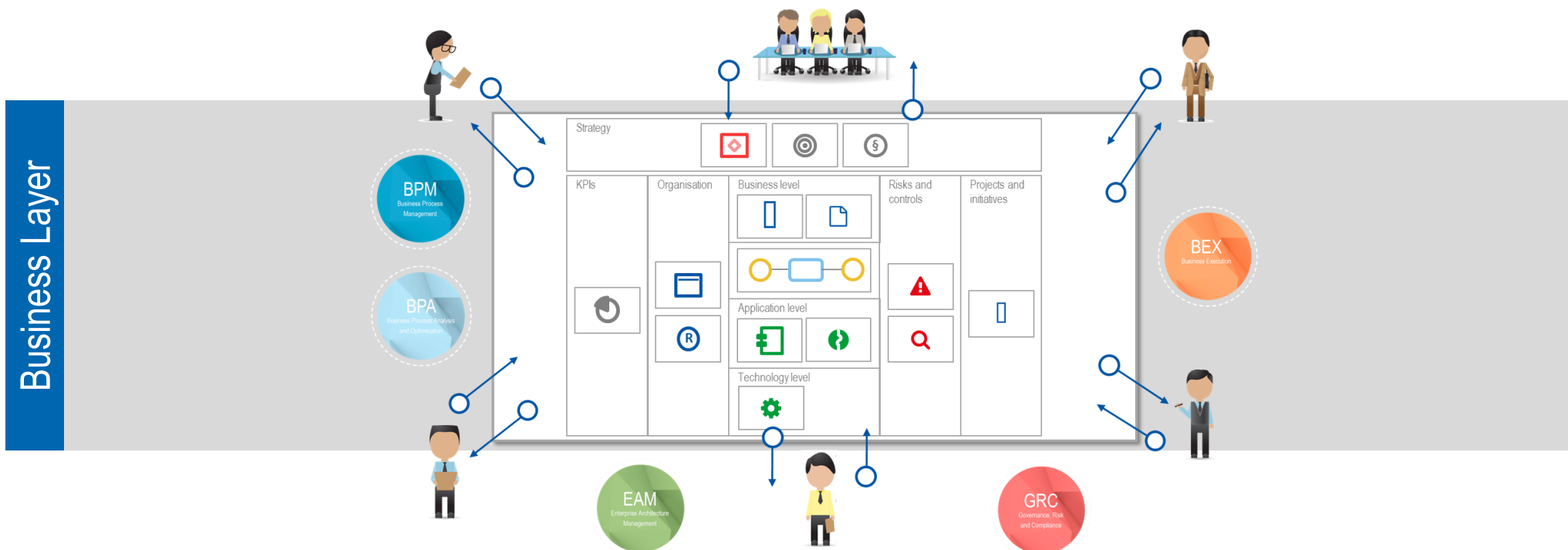

With ADONIS you are **flexible and independent** and you can change IT tools if your business requirements evolve

BOC Management Office Integration (MOI)



Integration of the Management Systems

ADONIS and ADOIT integration for an IT-supported introduction and anchoring of your management approaches in your company:

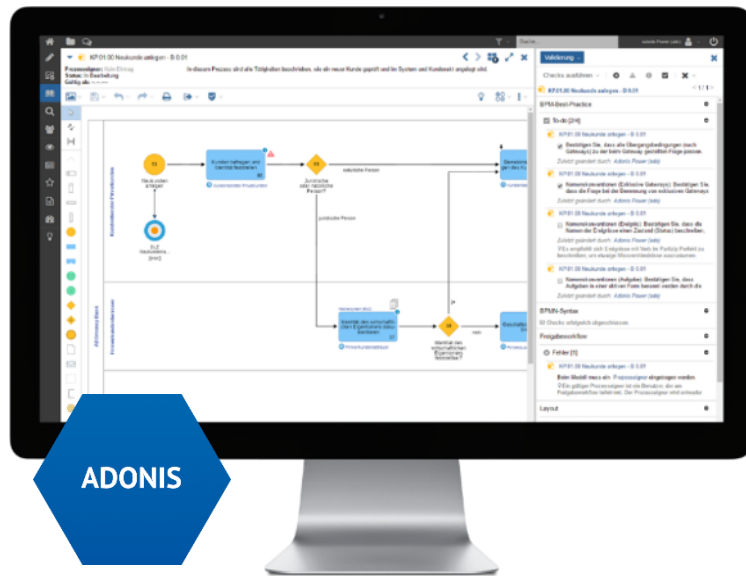

Business Process Management with ADONIS

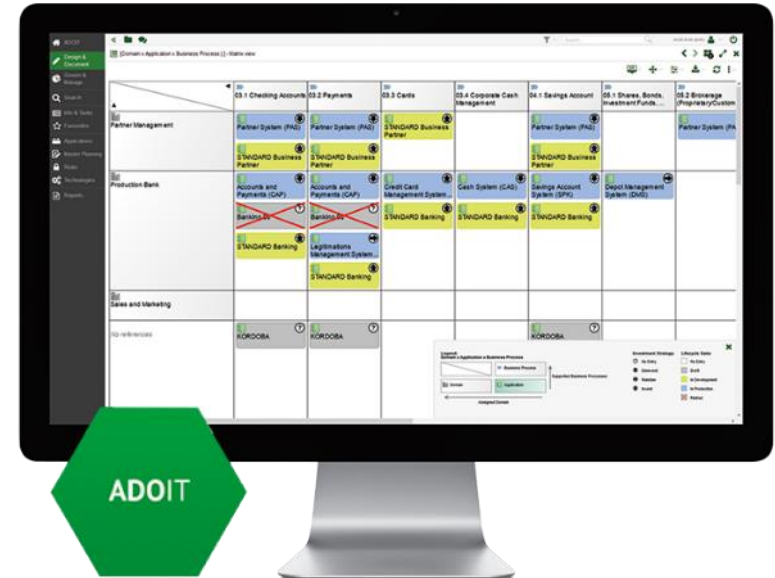
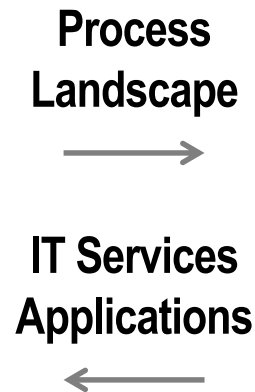

Enterprise Architecture Management with ADOIT

BOC Portal Integration Service – Overview



Direct Integration of ADONIS and ADOIT with collaboration tools such as Confluence

Enterprise Portal Page



- Content Owner
- Contributor
- Reader

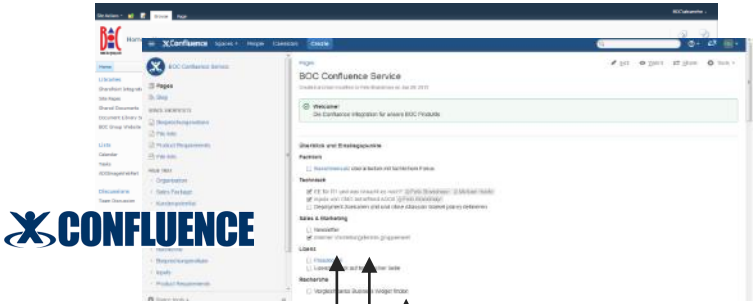

• Inform – Search



• Publish



• Document



• Collaborate

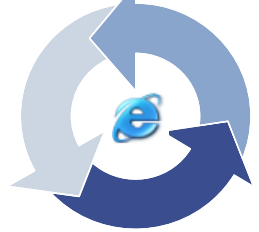

Enterprise Web Portal

ADONIS & ADOIT



Models

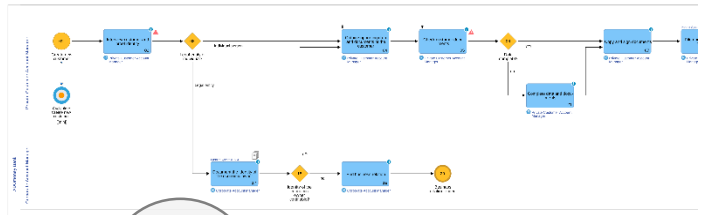

- Process Owner
- Process Participant
- Architect ...



Analyses

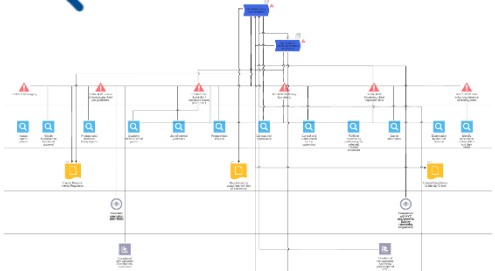

Dashboards

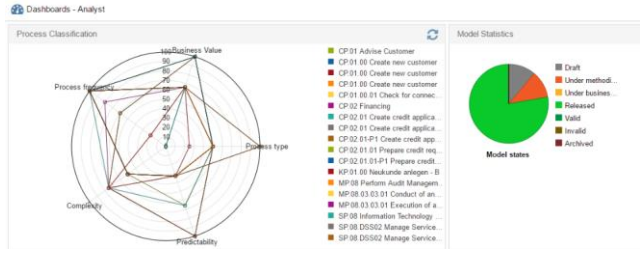

Repository



How ADONIS supports process execution

Comprehensive capabilities of integration with BPM/Workflow and further tools

- ▶ URL calls
- ▶ BPMN Diagram Interchange (XML)
- ▶ REST API
- ▶ Custom integrations

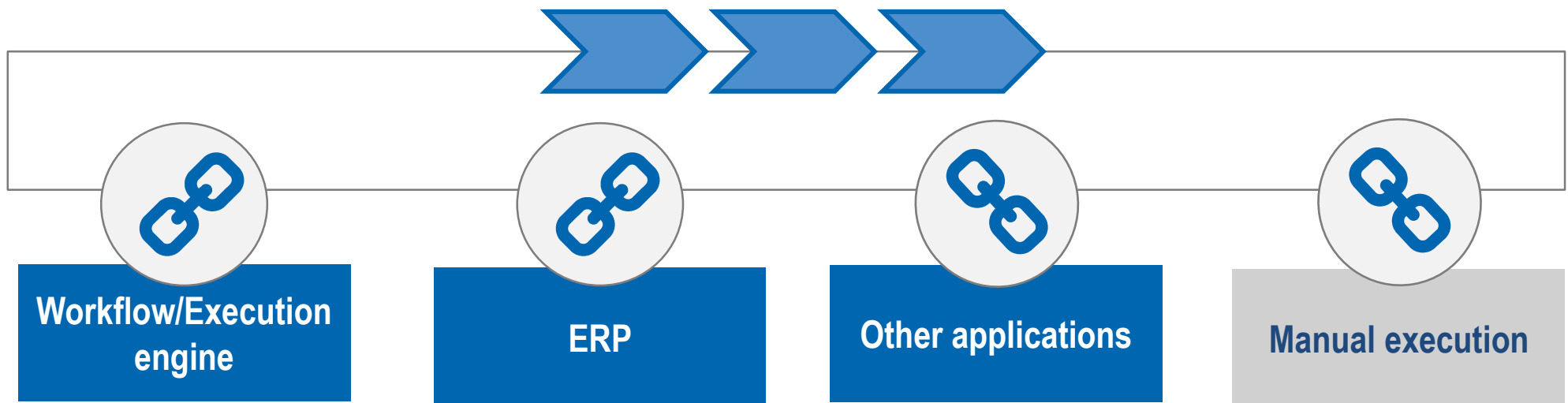

Automating processes with ADONIS

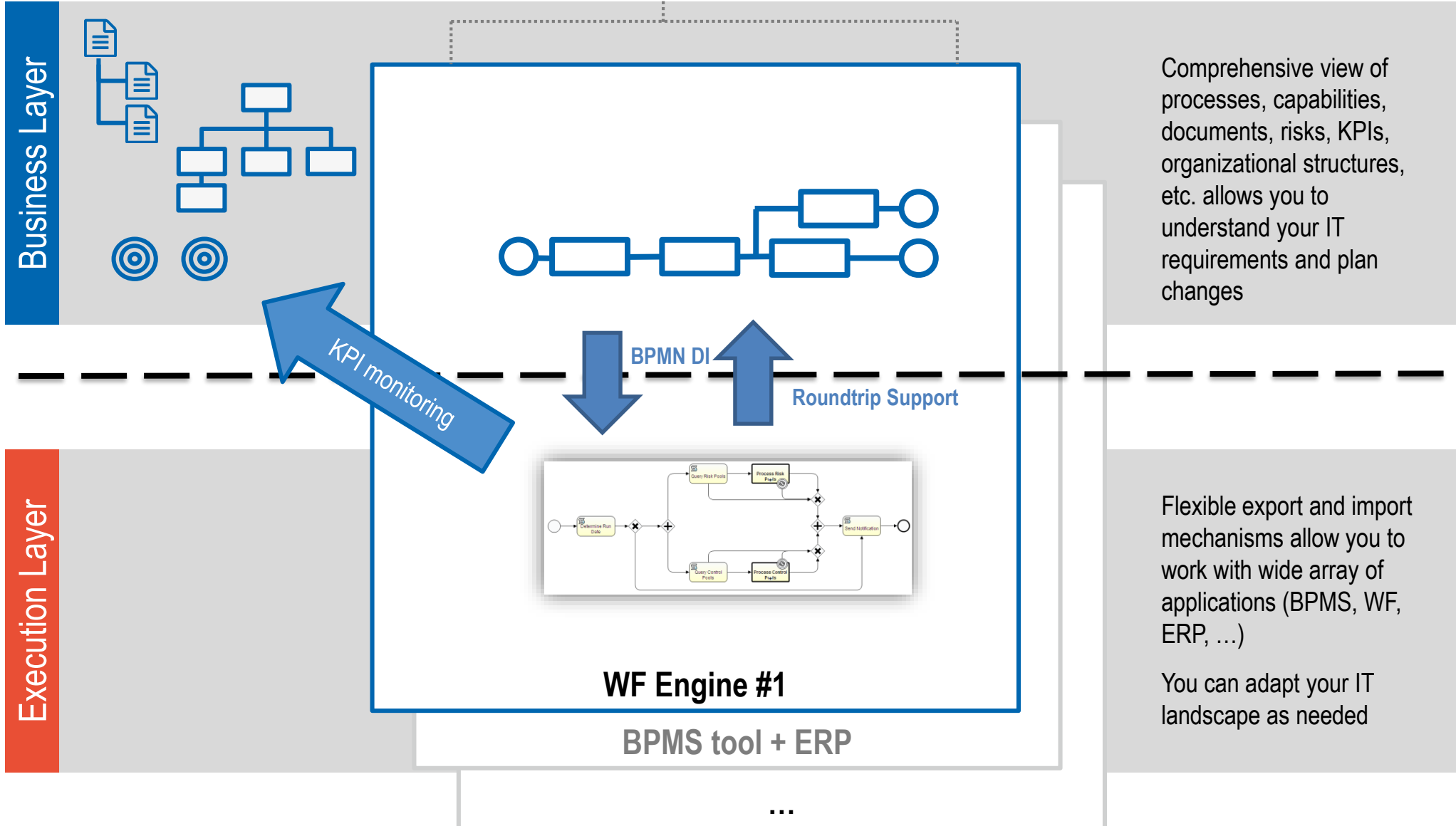

Business Layer

Execution Layer

Comprehensive view of processes, capabilities, documents, risks, KPIs, organizational structures, etc. allows you to understand your IT requirements and plan changes

Flexible export and import mechanisms allow you to work with wide array of applications (BPMS, WF, ERP, ...)

You can adapt your IT landscape as needed

Real life example – ADONIS and Camunda



Vacation request handling

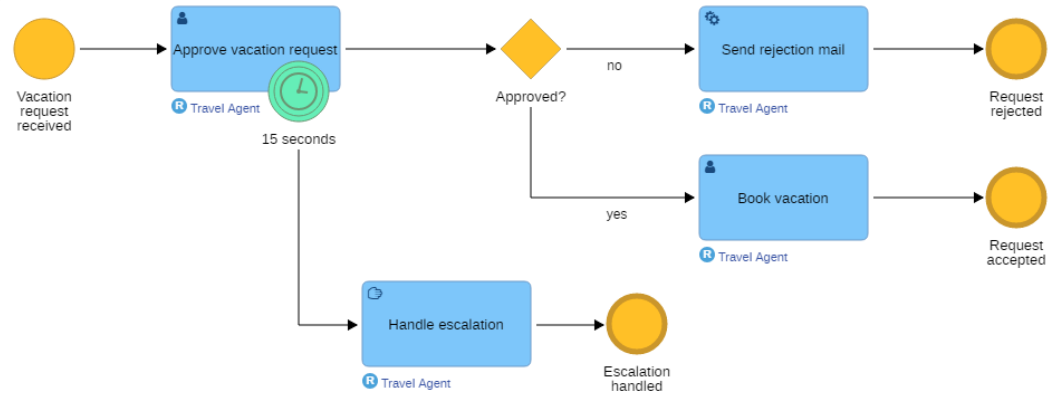

- ▶ Vacation request process created in ADONIS
- ▶ Moved to Camunda and extended with data and forms before execution

Transfer via



The screenshot shows the Eclipse IDE with a BPMN diagram for 'Vacation request handling (en)'. The diagram is identical to the one shown above. The 'Properties' panel at the bottom shows the configuration for a 'Sequence Flow "No"', including fields for 'Condition', 'Condition source', and 'Condition'.

The screenshot shows the Camunda tasklist interface. On the left, there is a sidebar with 'My Tasks' and 'My Group Tasks'. The main area displays a list of tasks, including 'Escalation task' with a due date of '3 minutes ago'. On the right, the 'Escalation task' details are shown, including a 'Form' tab with a table of variables:

Name	Type	Value
startDate	Date	2015-08-03T00:00:00
approved	Boolean	<input checked="" type="checkbox"/>
name	String	Falko
endDate	Date	2015-08-07T00:00:00
variable name	Variable type	Value

Real life example – ADONIS and Bonita

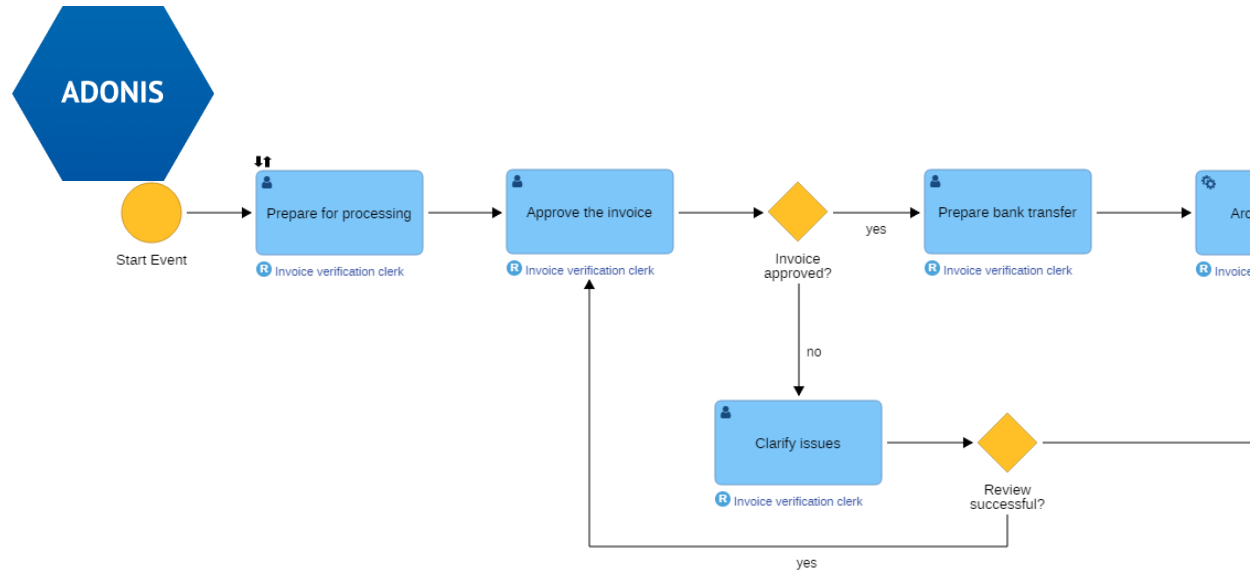

- ▶ Invoice approval process created in ADONIS
- ▶ Moved to Bonita and extended with data and forms before execution

Transfer via

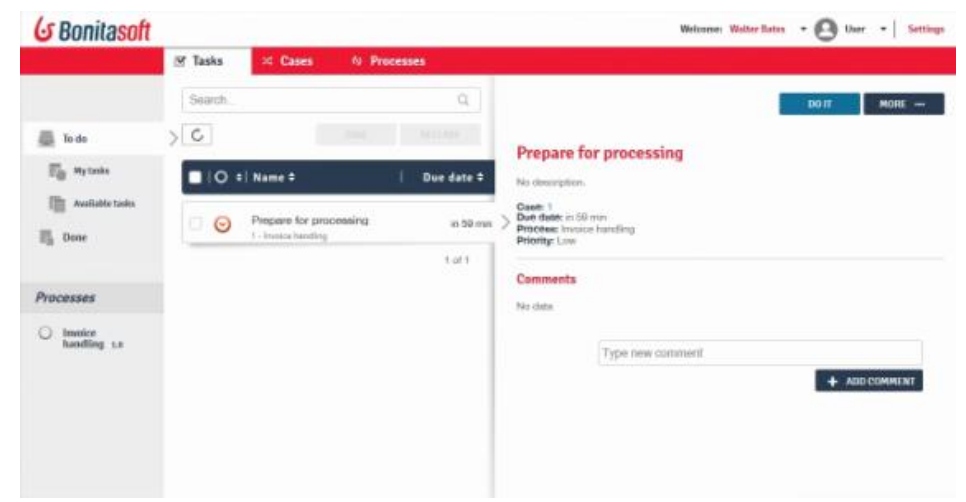
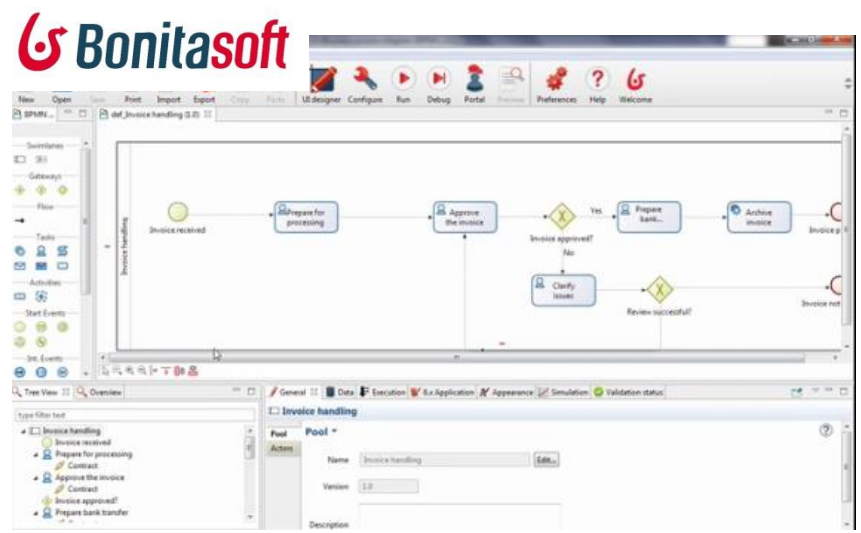

Easy interchange with other tools thanks to the support for standards



- ▶ BOC actively participates in BPMN, DMN and CMMN Task Forces
- ▶ Active member of the BPMN Model Interchange Working Group
 - ▶ You can learn more about BPMN MIWG from article on BPTrends.com we co-authored: <http://www.bptrends.com/making-bpmn-a-true-lingua-franca/>
 - ▶ Support for all test cases by BPMN MIWG (30+ tools tested)



BPMN Tools tested for Model Interchange

Search: <input type="text"/>											
Vendor	Tool	BPMN 2.0	Import	Export	Roundtrip	Demo Participation	Last Test Submission	A Results Submitted	B Results Submitted	C Results Submitted	Website
BOC Group	ADONIS NP 5.2	+	+ Diff	+ Diff	+ Details	+ 2017, 2016, 2015, 2014, 2013	+ 2017	+ 24/24	+ 8/8	○ 18/16	Website
Trisotech	Trisotech BPMN Modeler 5.2.0	+	+ Diff	+ Diff	+ Details	+ 2017, 2016, 2015, 2014, 2013	+ 2017	+ 24/24	+ 8/8	+ 16/16	Website
Esteco S.p.a.	BeePMN 1.3	+	+ Diff	+ Diff	+ Details	+ 2017, 2016	+ 2017	○ 16/24	● 0/8	+ 16/16	Website
Boris Zinchenko	BPMN View 1.0.4	+	+ Diff	●	● Details	+ 2017	+ 2017	○ 6/24	○ 2/8	○ 4/16	Website
Signavio GmbH	Signavio Process Editor 10.0.0	+	+ Diff	+ Diff	+ Details	+ 2017, 2016, 2015, 2014, 2013	○ 2016	+ 24/24	+ 8/8	+ 16/16	Website
W4 Software	W4 BPMN+ Composer V.9.4	+	+ Diff	+ Diff	+ Details	+ 2017, 2016, 2015, 2014, 2013	○ 2016	+ 24/24	+ 8/8	+ 16/16	Website
Camunda	Camunda Modeler 2.7.0	+	+ Diff	+ Diff	+ Details	+ 2017, 2016, 2015, 2014, 2013	○ 2015	○ 20/24	+ 8/8	+ 16/16	Website
itp-commerce	itp-commerce Process Modeler for MS Visio 6	+	+ Diff	+ Diff	+ Details	+ 2017, 2016, 2015, 2014, 2013	○ 2015	○ 20/24	+ 8/8	○ 2/16	Website
ModelFoundry Pty. Ltd.	ModelFoundry 1.1.1	+	+ Diff	+ Diff	+ Details	○ 2016	○ 2016	○ 12/24	○ 4/8	○ 8/16	Website
Camunda	bpmn.io 0.9.2	+	+ Diff	+ Diff	+ Details	○ 2016, 2015, 2014	○ 2015	○ 21/24	+ 8/8	+ 16/16	Website

Active member of OMG Model Interchange Working Group

- ▶ ADONIS participated in **all interchange demonstrations by BPMN MIWG** (including full roundtrip of hidden technical attributes introduced by execution engines)
- ▶ You can find the videos showing how to move from a documented process to running application on: <http://www.omgwiki.org/bpmn-miwg/doku.php>



Full list of tools tested by BPMN MIWG can be found on: <http://bpmn-miwg.github.io/bpmn-miwg-tools/>

Process Execution Integrations

Advantages with ADONIS



Works with BPMS/WF engines but is not tied to one of them

- Support for **full roundtrip of BPMN models**
- Active member of BPMN Model Interchange Working Group
- Allows you to **design your processes before you select BPMS vendor** and change automation tools if needed



Makes ERP implementations faster

- Documentation of standard software
- Test case preparation



Gives full managerial view

- Allows you to **design all processes – not only those fully automated**
- Shows which processes are supported by BPMS, ERP, CRM, ...



Facilitates Business-IT alignment

- „**BPMN fit for business**” provides relevant information for business users
- IT experts can use advanced filters to add more technical details
- Collaboration mechanisms help you engage all stakeholders



Prepares you for a Digital Transformation

- Comprehensive metamodel helps you **understand value creation and design new business models**
- Graphical analysis mechanism **shows the dependencies**



- I. Communication, Collaboration and Integration
- II. Summary**

Seven good reasons for Process Management with ADONIS



A professional process management platform



Easy and intuitive handling

- ▶ Clearly structured – “keep it simple“
- ▶ One tool for all roles



Open and flexible

- ▶ Comprehensive best practice modelling library with integrated BPMN 2.0 support
- ▶ Flexibility through metamodeling
- ▶ Open interfaces for execution



More than modelling

- ▶ Extensive functionality for process analysis and graphical reporting
- ▶ Integration of business scenarios e.g. ICS/RM, EAM, QM, KVP, etc.



Well-positioned for all future challenges

- ▶ From simple modelling to extensive management scenarios



Process management as team work

- ▶ Real-time documentation online
- ▶ Role-specific access to content over the web
- ▶ Role-based release workflow



All-in-one

- ▶ Technical platform, consulting and far-reaching know-how



Proven, world-wide

- ▶ In all sectors, on all continents, with more than 30,000 installations

ADONIS – make processes work

Market Presence – Key Figures



98%  of clients on Maintenance Contract

1120 ADONIS Customers 
from which most are on the latest release version and **960** of which bought or upgraded last year

Over **75%** of clients serve as  **References**

Average Deployment Time  **2 Days**

Installed Base
1,400+
of **Customer** of BOC Products

Community of **90,000+** users 
of the **Community** and **Cloud** versions of BOC Products

The BOC Group in Social Media

ADONIS

Follow us on LinkedIn



**ADONIS -
Business Process Management**

Showcase page



BOC Group

Company page



**ADOIT -
Enterprise Architecture**

Showcase page

Follow us on Twitter: **@BOC_Group**



BOC Group Evaluated by Global Market Study Research Firms

ADOIT



FORRESTER[®]

[View report](#)

The Forrester Wave

Enterprise Architecture Management
Suites Q2 2017



Gartner[®]

[View report](#)

Gartner Magic Quadrant

2017 Magic Quadrant for Enterprise
Architecture Tools



Fraunhofer

[View report](#)

Fraunhofer Market Study

Metadata Management Tools for
Enterprise Architecture Management



Ovum
TMT intelligence | informa

[View report](#)

Ovum On The Radar Report

On The Radar Report, Published
June 29th, 2017

* The Forrester Wave[™], EA Management Suites, Q2 2017, Forrester Research, Inc., June 14, 2017

* Fraunhofer-Gesellschaft, <https://www.fraunhofer.de/>

* GARTNER is a registered trademark and service mark of Gartner, Inc. and/or its affiliates in the U.S. and internationally, and is used herein with permission. All rights reserved.

* Ovum, <https://ovum.informa.com/>

BOC Group Named a worldwide “Leader” Among EA Suites

ADOIT

BOC Group received the highest score among all vendors in the Strategy category

The screenshot shows the Forrester website interface. At the top, there is a navigation bar with links for 'research', 'data', 'connect', 'consulting', 'events', and 'analysts', along with a 'log in' button. Below the navigation bar is a search bar. The main content area features a report titled 'The Forrester Wave™: Enterprise Architecture Management Suites, Q2 2017' by Gordon Barnett, with Alex Cullen and Madeline King. The report is dated June 14, 2017. Below the title, there is a section titled 'Why Read This Report' and another titled 'Tools And Templates' with a sub-section 'Vendor Selection Aids'. The 'Tools And Templates' section includes an icon of a document and a bar chart, and mentions 'Forrester Wave™: Enterprise Architecture Management Suites, Q2 '17'.

Characteristics of the report:

- ✓ Researched, analysed, scored and ...
- ✓ identified the global 10 most significant EA solution providers ...
- ✓ based on a 40-criteria evaluation ...
- ✓ grouped into three high-level categories:
 - Current Offering
 - Strategy
 - Market Presence

 **BOC Group Ranked 1st in EA Suites in the Strategy category!**

*“BOC Group is competitive in all criteria but is particularly strong in IT asset management and IT portfolio management.”**

* The Forrester Wave™, EA Management Suites, Q2 2017, Forrester Research, Inc., June 14, 2017

BOC Group Ranked 1st in EA Suites in Strategy Category

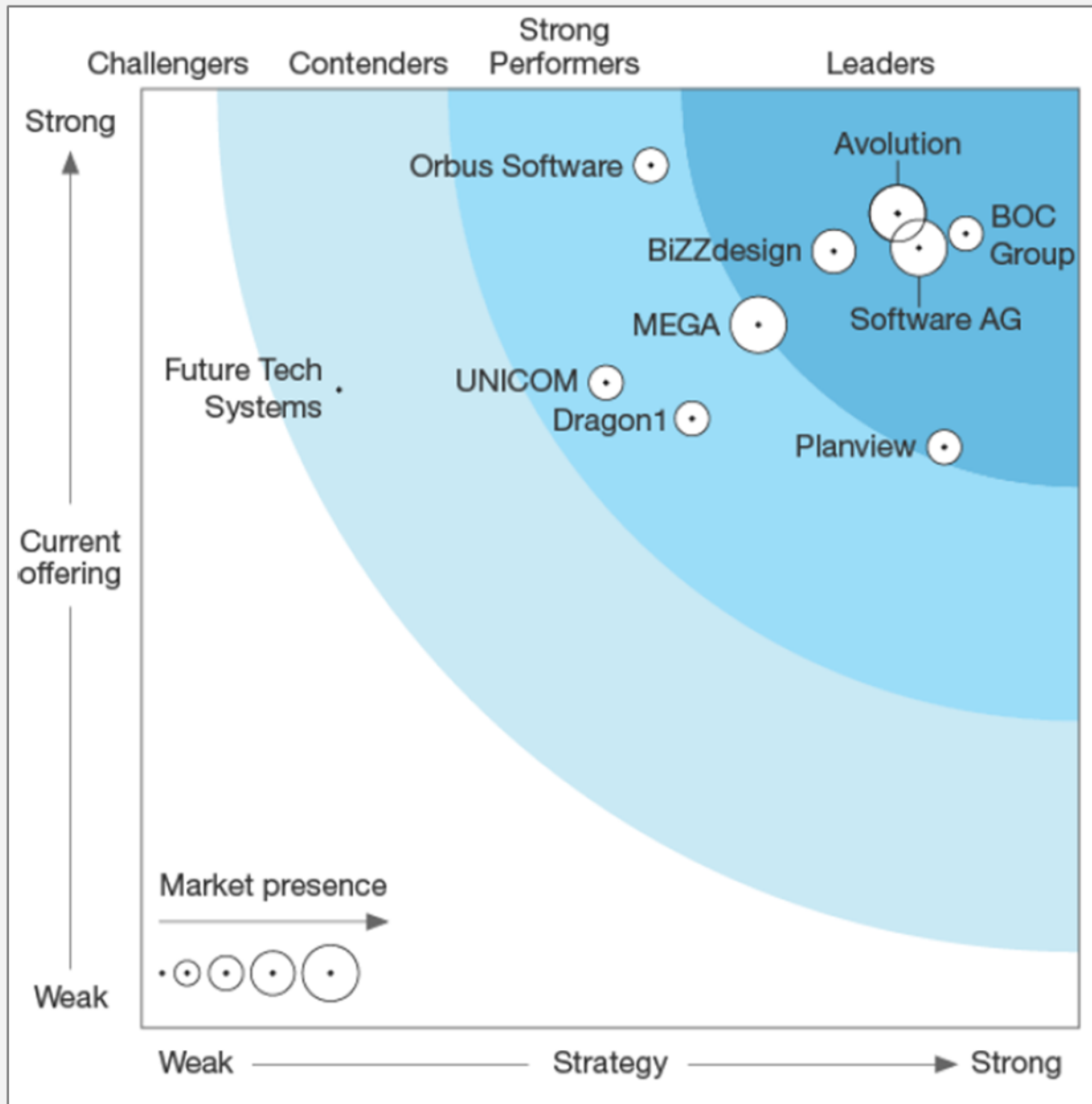

The Forrester Wave

Enterprise Architecture Management Suites – Q2 2017

The Forrester Wave™ is copyrighted by Forrester Research, Inc. Forrester and Forrester Wave™ are trademarks of Forrester Research, Inc. The Forrester Wave™ is a graphical representation of Forrester's call on a market and is plotted using a detailed spreadsheet with exposed scores, weightings, and comments. Forrester does not endorse any vendor, product, or service depicted in the Forrester Wave. Information is based on best available resources. Opinions reflect judgment at the time and are subject to change.*

* The Forrester Wave™, EA Management Suites, Q2 2017, Forrester Research, Inc., June 14, 2017

BOC Group Webinars



Discover our Comprehensive Offering of free Webinars



ON-DEMAND BPM WEBINAR

Maturity and Performance of BPM, Digital Transformation, ISO 9001:2015, Workflow-based Process Execution, Process Optimization and many more!

ON-DEMAND EA WEBINAR

Value Creation through Architecture Management, How to start your EA, EU-GDPR, Optimize your IT, Making Archimate business fit and many more!

FURTHER WEBINARS

Achieve Success in Quality, Process and Risk Management, End-to-End Transformation, Knowledge Management, Confluence Integration and many more!

www.boc-group.com/webinars

More than 25 free live or on-demand webinars on current industry-relevant topics in three languages!

Join our free Webinars:
www.boc-group.com/webinars

Fancy to work at BOC Group?



We certainly got the right thing for you



- ✓ Bachelor or Master Thesis
- ✓ Internships and Practical Work Experience
- ✓ Exciting Job Offers with great Career Opportunities in Consulting, Sales, Programming and much more

Simply get in touch with us!

www.boc-group.com/career



For further information...

... please get in touch with us!



Do you have a specific request?

Contact us at www.boc-group.com/contact.

Connect with us!

Follow us and feel our heartbeat.

